

Pembroke 52

DU-PEM-52-IO



Undermount / Drop in basin

- Made from ENGLISHCAST™
 - One piece casting of Volcanic Limestone™ and resin
 - Harder & more durable than acrylic
- Can be undermounted or dropped in
- Easy clean high gloss finish
- Integrated internal overflow
- 25 year warranty



Plan vasque à semi-encastrer ou à encastrer par le dessous

- Fabriquée en ENGLISHCAST™
 - Ensemble d'une pièce en pierre volcanique rare et résine
 - Matériau plus dur et plus résistant que l'acrylique
- Vasque à poser ou à semi-encastrer
- Fini ultra brillant, facile à nettoyer
- Trou de trop-plein intégré
- Garantie de 25 ans



Lavabo bajo encastre / semi encastrado

- Hecho de ENGLISHCAST™
 - Hecho en una pieza de piedra volcánica y resina
 - Más resistente y duradero que acrílico
- Con posibilidad de instalarlo sobre la encimera o semiencastrado
- Fácil de limpiar y acabado brillante
- Dispositivo interno integrado para protección ante desbordamientos
- 25 años de garantía

25
years

Warranty for residential use for 25 years*
25 ans de garantie pour un usage domestique*
Garantía de 25 años para uso domestico*

8
years

Warranty for commercial use for 8 years*
8 ans de garantie pour un usage commercial*
Garantía de 8 años para uso comercial*

Pembroke 52

DU-PEM-52-IO

Special Options/Options spéciales/Opciones especiales

Recommended: K22/K24/K25/K122

Conseillé / Recomendado



Internal overflow
Trop-plein interne
Rebosadero integrado



K24



K25



K22



K122

Related collections

Collections connexes / Colecciones relacionadas



Pembroke



Florin faucets - FLO-09



Undermount

Pembroke 52



Drop-in

Pembroke 52

Pembroke 52

DU-PEM-52-10

Top view

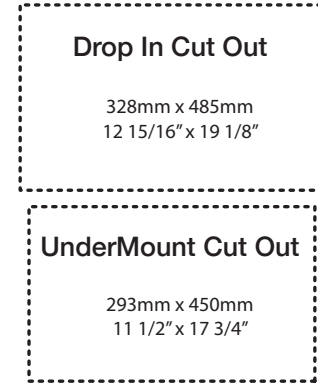
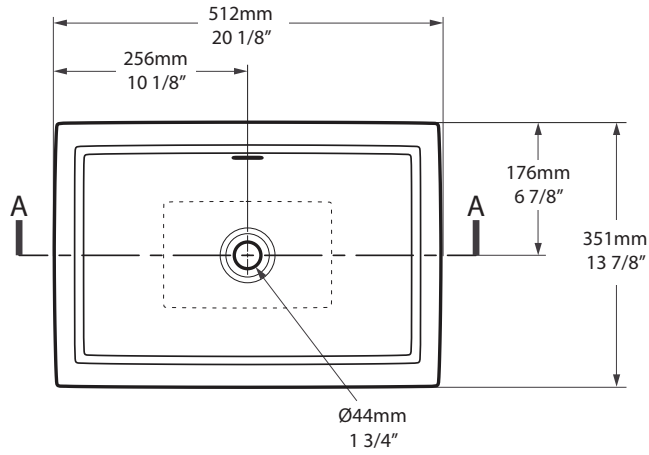

Front view

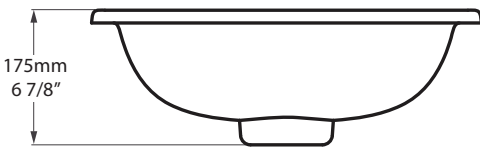

Side view

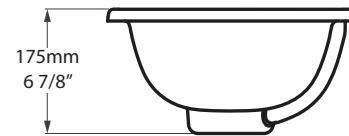

Section AA

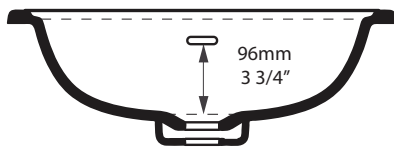

*All measurements subject to +/-5% tolerance

l = 512mm / 20 1/8"
w = 351mm / 13 7/8"
h = 175mm / 6 7/8"

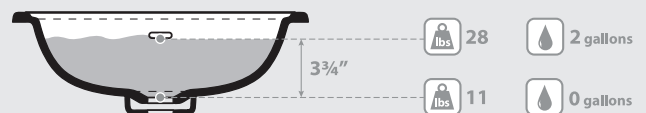
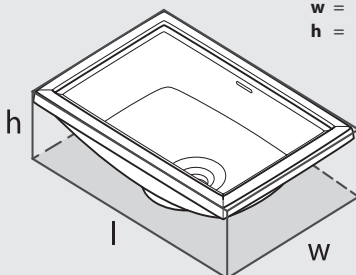

.dwg | .dxf | .skp www.vandabaths.com



Massachusetts Code: Approved
 cUPC listing by IAPMO: File No. 6574



VA/1181/06/Jan19