

Metallo 61 Quartz

MET-61-QWH-N-PC
 MET-61-QWH-1TH-PC
 MET-61-QWH-3TH-PC

MET-61-QBK-N-PC
 MET-61-QBK-1TH-PC
 MET-61-QBK-3TH-PC

MET-61-QBT-N-PC
 MET-61-QBT-1TH-PC
 MET-61-QBT-3TH-PC



Quartz-topped washstand with an undermounted Kaali 46 basin

- Choice of White, Black or Biscuit Quartz top
- Removable upstand in same material finish
- Option to order with or without faucet/tap holes
- Two legs with distinctive tee joint detailing
- Towel rail and rack for storage
- Wall anchors included



Lavabo avec surface en Quartz et vasque encastrée Kaali 46

- Au choix : surface en Quartz Blanche, Noire ou Biscuit
- Crédence amovible dans le même matériau de finition
- Possibilité de commander avec ou sans trou de robinetterie
- Deux pieds avec finition des jointures en T
- Porte-serviette et support pour le rangement
- Elements d'ancrage mural inclus



Palanganero con encimera de cuarzo y lavamanos encastrado Kaali 46

- Encimera en blanco, negro o marrón cuarzo
- Soporte desmontable en el mismo material y acabado
- Con posibilidad de solicitarlo con o sin orificios para la grifería
- Incluye dos patas con los clásicos detalles en las uniones
- Soporte toallero y balda para almacenaje
- Incluye los anclajes de pared

Metallo 61 Quartz

MET-61-QWH-N-PC / MET-61-QWH-1TH-PC / MET-61-QWH-3TH-PC
 MET-61-QBK-N-PC / MET-61-QBK-1TH-PC / MET-61-QBK-3TH-PC
 MET-61-QBT-N-PC / MET-61-QBT-1TH-PC / MET-61-QBT-3TH-PC

Special Options/Options spéciales/Opciones especiales



Colour

Use codes on right to determine SKU.
 The colours shown here are not exact representations.
 Utiliser le code à droite pour déterminer la référence produit.
 La couleur présentée n'est pas la nuance réelle.
 Utiliza el código a la derecha para determinar el SKU.
 Los colores presentado aquí, pueden variar a la realidad.



QBK MET-61-**QBK**-xx-PC



QBT MET-61-**QBT**-xx-PC



QWH MET-61-**QWH**-xx-PC

QBK Polished chrome & Black / Chromé & Noir / Cromado pulido & Negro
QBT Polished chrome & Biscuit / Chromé & Biscuit / Cromado pulido & Biscuit-beige
QWT Polished chrome & White / Chromé & Blanc / Cromado pulido & Blanco



Faucet Holes

Trou de robinetterie / Agujeros para grifos

Option to order with or without pre-drilled faucet holes
 Option de commande : avec ou sans trou de robinetterie
 Disponible con o sin agujeros pretaladrados para grifos



MET-61-Qxx-N-PC

No faucet holes
 Sans trou de robinetterie
 Senza fori per rubinetti



MET-61-Qxx-1TH-PC

1 pre-drilled faucet hole
 1 trou de robinetterie pré-percé
 Con 1 agujero pretaladrado para grifos



MET-61-Qxx-3TH-PC

3 pre-drilled faucet holes
 3 trous de robinetterie pré-percés
 Con 3 agujeros pretaladrados para grifos

Recommended: K22/K24/K25/K122

Conseillé / Recomendado



Internal overflow
 Trop-plein interne
 Rebosadero integrado



K24



K25



K22



K122

Related Collections

Collections connexes / Colecciones relacionadas



Staffordshire taps - STA-09



Florin taps - FLO-09

Metallo 61 Quartz

MET-61-QWH-N-PC / MET-61-QWH-1TH-PC / MET-61-QWH-3TH-PC
 MET-61-QBK-N-PC / MET-61-QBK-1TH-PC / MET-61-QBK-3TH-PC
 MET-61-QBT-N-PC / MET-61-QBT-1TH-PC / MET-61-QBT-3TH-PC

Front View

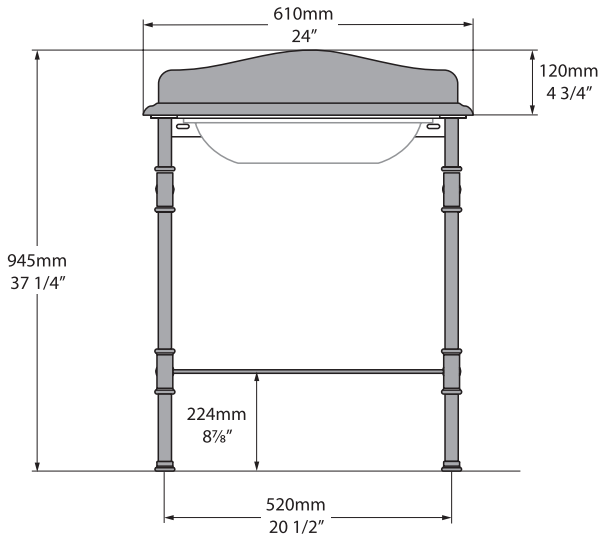

Side view

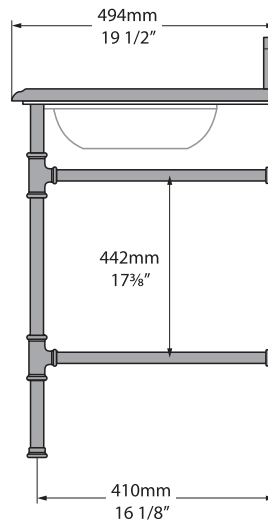

Section AA

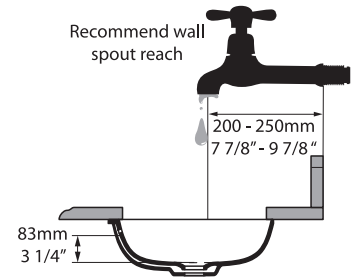

MET-61-Qxx-N-PC
 MET-61-Qxx-1TH-PC
 MET-61-Qxx-3TH-PC

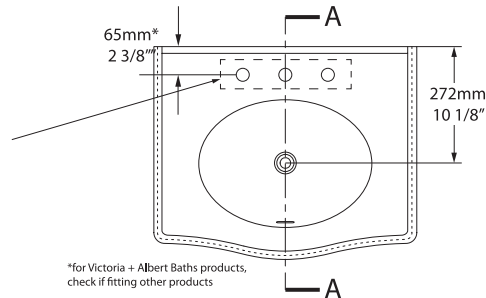
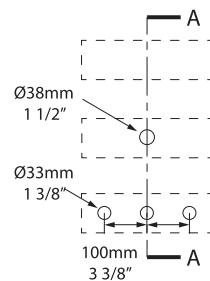

Tap holes can be drilled by installer
 Les trous de robinetterie peuvent être percés par l'installateur
 Pueden ser perforados por el instalador

*All measurements subject to +/-5% tolerance

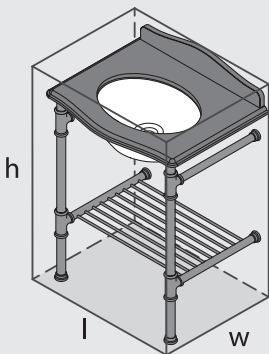

l = 610mm / 24"
w = 494mm / 19 1/2"
h = 945mm / 37 1/4"

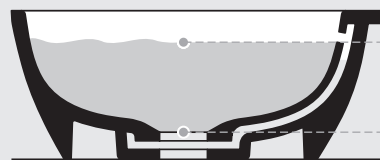

79 lbs

1 1/4 gallons

68 lbs

0 gallons



.dwg | .dxf | .skp www.vandabaths.com



Massachusetts Code: File No. Pending
 cUPC listing by IAPMO: File No. Pending



VA/1181/03/Jan19